

S3000.EHO
 BS EN1155:1997+A1:2002
 3 5 3 1 1 3
 2812 CPR-AE019
 APPROVED PRODUCT CFS312
CE
 20

S3400.EHO
 BS EN1155:1997+A1:2002
 3 5 3 1 1 3
 2812 CPR-AE019
 APPROVED PRODUCT CFS312
CE
 20

S3500.EHO
 BS EN1155:1997+A1:2002
 3 5 3 1 1 3
 2812 CPR-AE019
 APPROVED PRODUCT CFS312
CE
 20

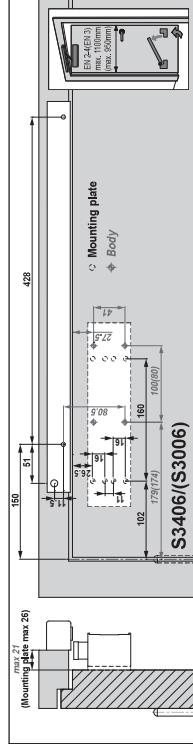
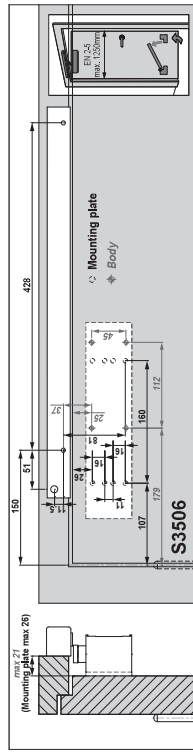
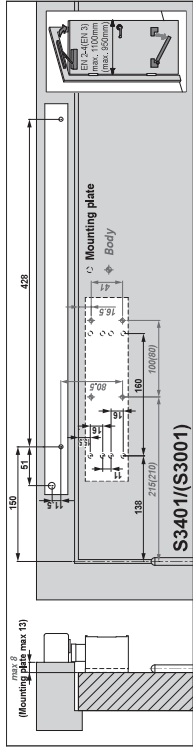
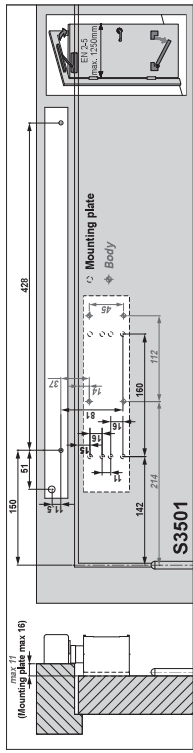

Installation and Maintenance Instructions:



Warning

1. Ensure that all electric to the door is shut off before installation of the device begins.
2. Ensure that the correct operating voltage (24VDC +/-15%) and power input of 1.4W is running to the device.
3. Ensure that the door does not exceed the maximum hold open angle as stated in these instructions.
4. Care and attention must be taken when adjusting any of the control valves to avoid damage and failure of the device.
5. All Synergy door closing devices are sealed for life and the internal components assembled under high load, therefore, tampering with the mechanism, track or electrical components is to be strictly avoided.

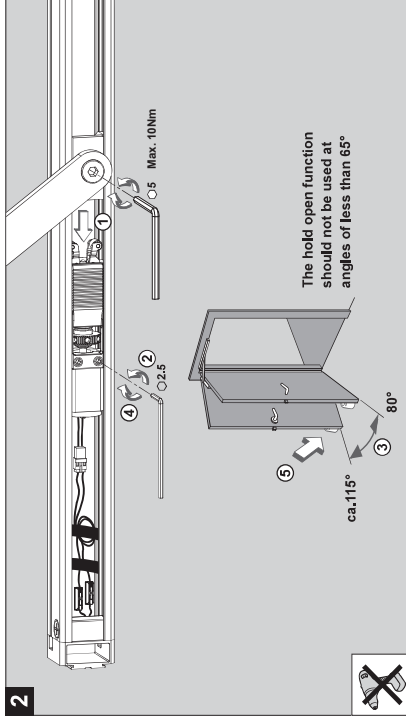
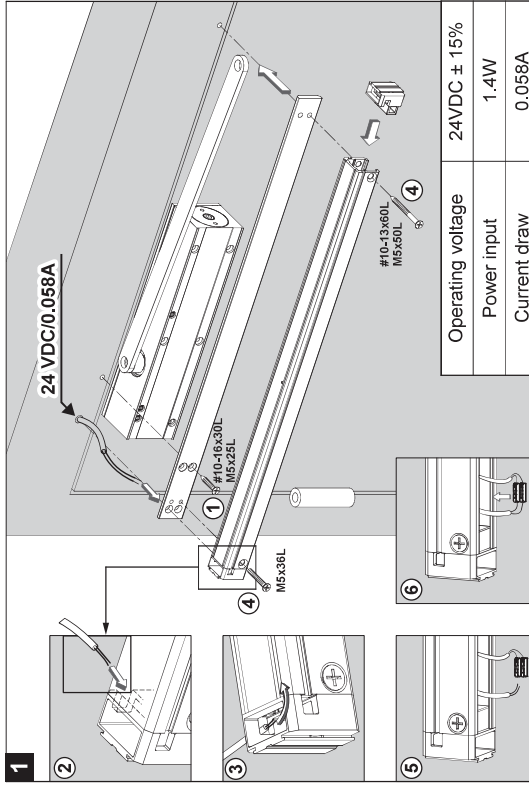

Operating voltage	24VDC ± 15%
Power input	1.4W
Current draw	0.058A

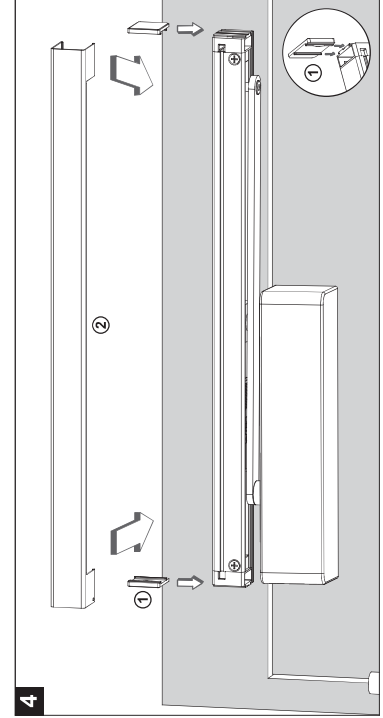
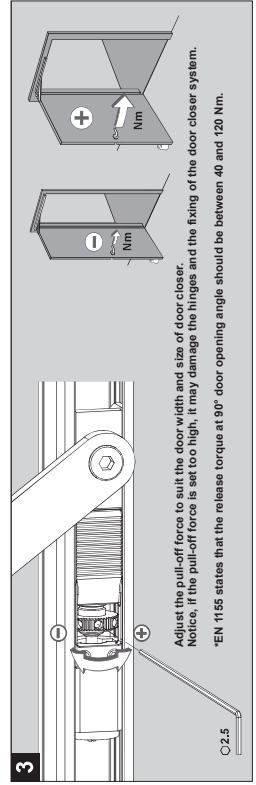

After installation (Electrical / Power Check)



1. With the power on, open door to maximum hold open angle and release. Door should remain in its hold open state. If door does not hold and closes, check power input and repeat test.
2. With the door in the powered hold open position, perform a fire alarm test to cut the power to the device. Door should close immediately and fully into its frame.
3. With the power on and door in hold open state, pull door from hold open and release. Door should close normally and fully as a normal door closing device.
4. If any of these tests fail, please repeat installation checks.



Maintenance

1. Once the unit has been correctly installed, please repeat the electrical checks on a regular basis, depending on the requirements of the building.
2. Please perform door pull off hold checks on a regular basis and ensure holding force remains stable whilst power is on.
3. Ensure all fixings are tight and the door closes freely and fully into its frame without slamming.
4. Should any lubrication be required, please apply only to connecting arm joints and any exposed pivot joints
(DO NOT LUBRICATE ANY OF THE ELECTRICAL OR SOLENOID COMPONENTS)